

**SOĞUTUCU PROFİLLERİ VE AKSESUARLARI**  
**COOLER PROFILES & ACCESSORIES**

**ALÜMİNYUM / ALUMINUM**

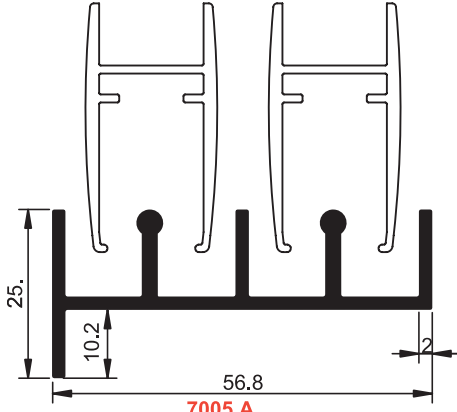

**TÜRK PATENT [ ] ENSTİTÜSÜ**



**7005 A**  
0.820 kg/m  
Tek Camlı Sürgü Profili

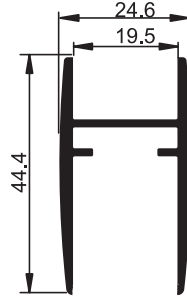

**7005**  
0.820 kg/m  
Isıcamlı Sürgü Profili

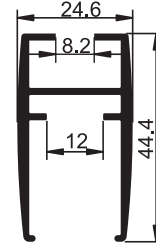

**7005 E**  
0.610 kg/m  
Tek Camlı Sürgü Profili

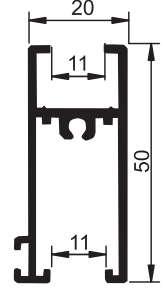

**7005 C**  
0.660 kg/m  
Isıcamlı Sürgü Profili

Kıl Fıtil



**7005 D**  
0.653 kg/m  
Tek camlı Sürgü Profili

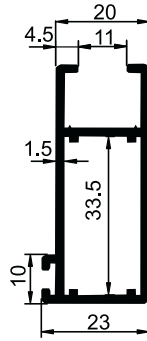

**7005 L**  
0.632 kg/m  
Isıcamlı Sürgü Profili

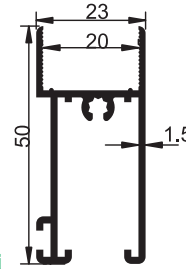

**7005 M**  
0.629 kg/m  
Isıcamlı Sürgü Profili

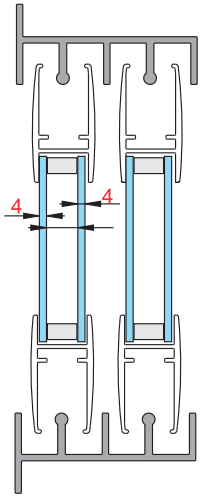
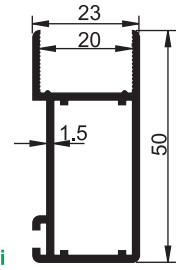

**7005 B**  
Tekli Rulman

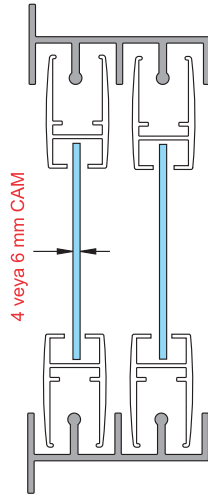

**7005**  
Rulman Sabitleme Pulu

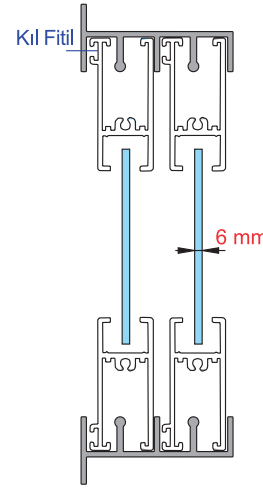

**7005 C**  
Köşe Bağlantısı

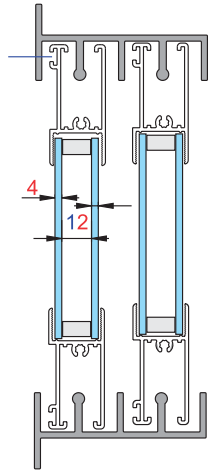

**7005**  
Köşe Bağlantısı



**7005 B**  
Çiftli Rulman



**7005 C**  
Köşe ve Rulmanlı

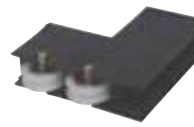

**DİK DOLAP ASKILI SÜRGÜ PROFİLLERİ**  
**VERTICAL GLASS DOOR PROFILES**

**7005 G**

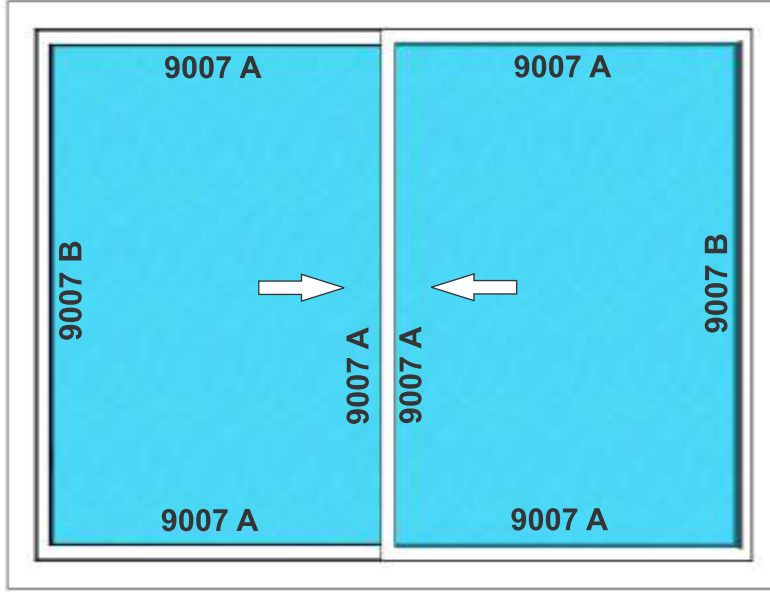





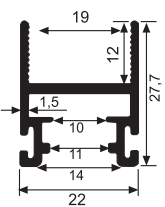
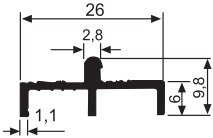
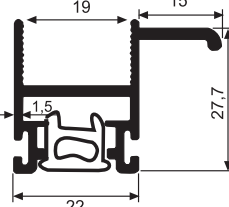
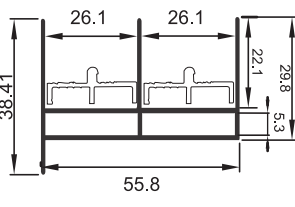
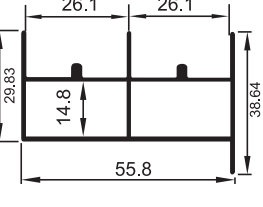

**7005 G OR 7005 H**

**7005 G OR 7005 H**

**7005 G + 9007 C**  
**OR 7005 H**



				
<b>9007 A</b> 0,400 kg./mt	<b>9007 C</b> 0,147 kg./mt	<b>9007 B</b> 0,485 kg./mt	<b>7005 G</b> 0,660 kg/m Üst Ray	<b>7005 H</b> 0,740 kg/m Alt ve Yan Ray

					
Dikdolap Üst Klavuz	9007 A köşe Bağlantısı	Dikdolap Rulman Takımı	Dik Dolap Üst Klavuz	Dik Dolap Rulman Takımı	Yay

**ALÜMİNYUM / ALUMINUM**  
**PVC SÜRGÜ PROFİLLERİ**  
**PVC SLIDING DOOR PROFILES**

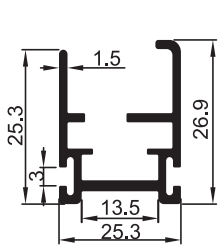

**7005 F**  
0.410 kg/m  
Isıcam Kanat Profili

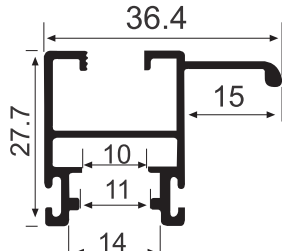

**9007 E**  
0.440 kg/m

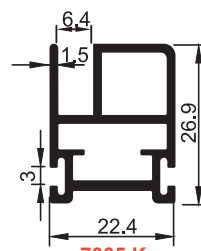

**7005 K**  
0.440 kg/m  
Tek Cam Kanat Profili

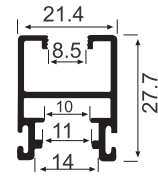

**9007 D**  
0.378 kg/m  
Tek Cam Kanat Profili

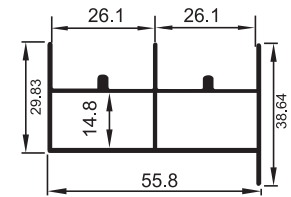
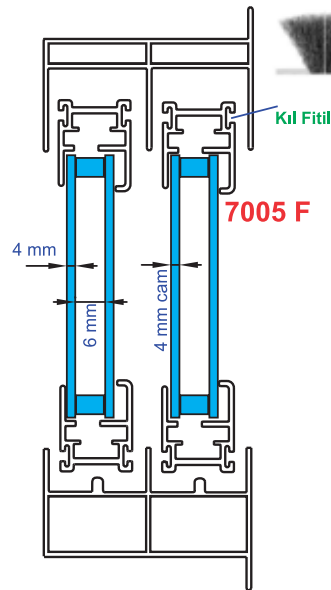
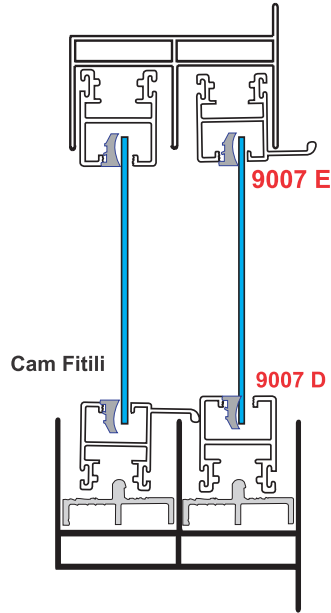
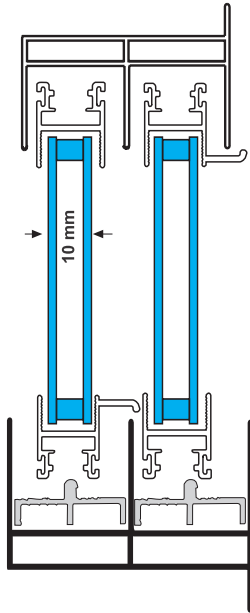

**7005 H**  
0.740 kg/m  
Alt ve Yan Ray

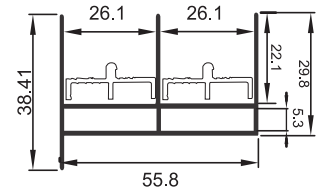

**7005 G**  
0.660 kg/m  
Üst Ray

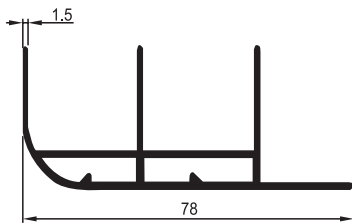

**9007**  
0.854 kg/m

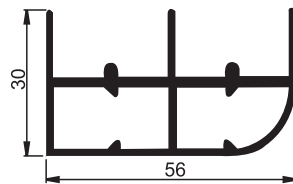

**9008**  
0.832 kg/m

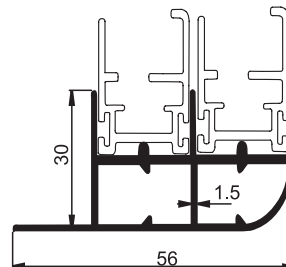

**9009**  
0.921 kg/m

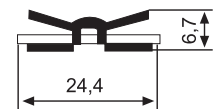

**7005 F Dikdolap Stop Fitili**



**DİKDOLAP**  
7005F/K  
KÖŞE İNCE



**DİKDOLAP**  
7005G KÖŞE  
L 40\*40



**DİKDOLAP**  
7005H ÇAVUŞ



**Dikdolap**  
Alüminyum Kulp



**Dikdolap Rulmanı**



**7005 F**  
Cam Fitili



**apışkanlı Stop Fitil**

**PVC SÜRGÜ PROFİLLERİ**  
**PVC SLIDING DOOR PROFILES**

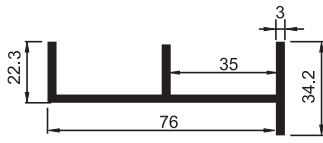
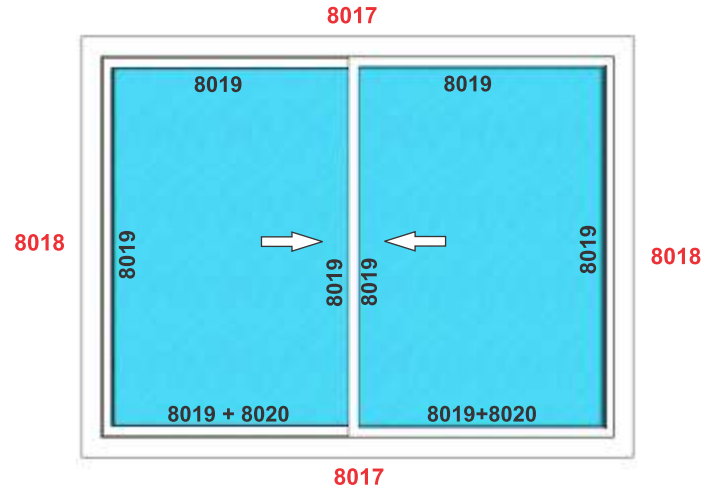
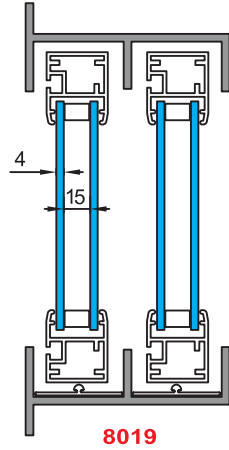

**8017**  
**Alt Ve Üst Ray**  
**Renk Seçeneği: Gri veya Siyah**

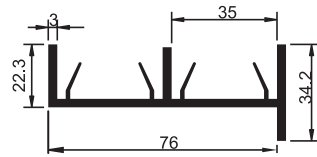

**8018**  
**Yan Ray**  
**Renk Seçeneği: Gri veya Siyah**

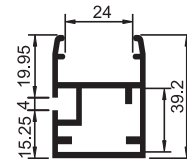

**8019**  
**Sürgü Kanalı**  
**Renk Seçeneği: Gri veya Siyah**

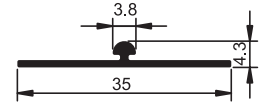

**8020**  
**0.142 kg/m**  
**Ray Alm.**



**8019 Köşe Bağlantısı**



**Kıl Fital**



**7005 F Rulman**



**Dik Dolap Yayı**

## ALÜMİNYUM / ALUMINUM

Sürgü Profilleri  
Sliding profiles

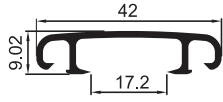

**7013**  
0.290 kg/m  
Mercedes Süs Çıtası

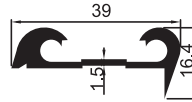

**7014**  
0.430 kg/m  
Tekne Kenarı

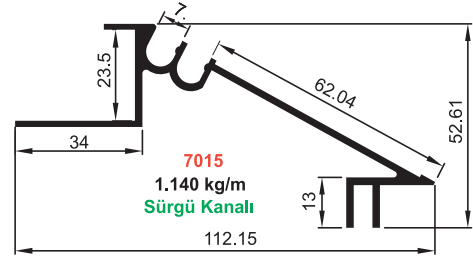

**7015**  
1.140 kg/m  
Sürgü Kanalı

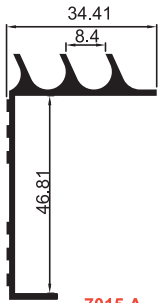

**7015 A**  
0.610 kg/m  
Sürgü Kanalı

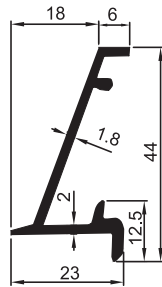

**7016**  
0.410 kg/m  
Raf Tırnağı

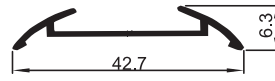

**7017**  
0.155 kg/m  
Etiketlik

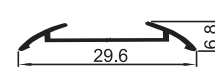

**7017 A**  
0.125 kg/m  
Etiketlik



**7018**  
0.500 kg/m  
Damlalık

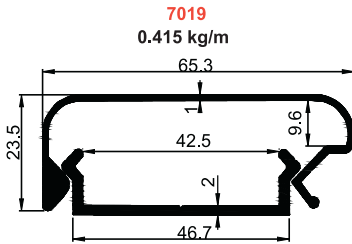

**7019**  
0.415 kg/m

**7019 A**  
0.395 kg/m  
Raf Tırnağı

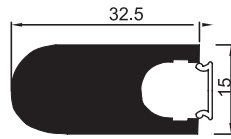

**7020**  
1.170 kg/m  
Kablo Kanallı  
Önden Destek Laması

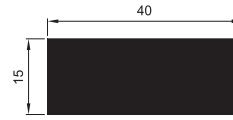

**7020 A**  
1.650 kg/m  
Önden Destek Laması

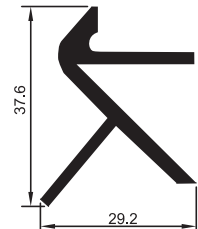

**7021**  
0.700 kg/m  
Dayama

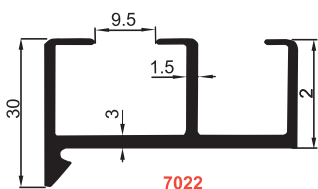

**7022**  
0.670 kg/m  
Sürgü Kanalı

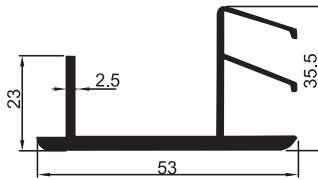

**7022 A**  
0.660 kg/m  
Amortisörlü Arka Sürgü Kanalı

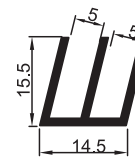

**7023**  
0.245 kg/m  
Dayama

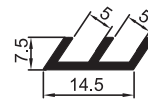

**7024**  
0.150 kg/m  
Dayama



**7025**  
0.420 kg/m  
Sütük Önü Tekli  
Üstten Askı Rayı

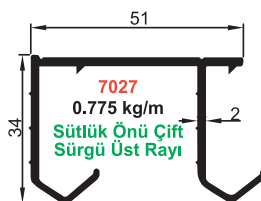

**7027**  
0.775 kg/m  
Sütük Önü Çift  
Sürgü Üst Rayı

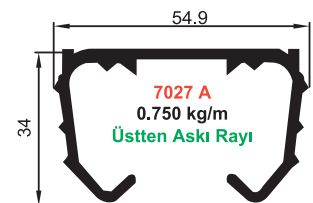

**7027 A**  
0.750 kg/m  
Sütük Önü Çift  
Sürgü Üstten Askı Rayı